



**BIT** Furniture



P.O. Box: 17248, Jebel Ali, Dubai - UAE  
Tel.: 00971 4 8817640 Fax: 00971 4 8811563  
Email: bitfurniture@albilad.ae | info@albilad.ae  
www.albiladfc.co

**Banquet** Catalog

COLLECTION

Established in 1995, AL BILAD INDUSTRIES & TRADING FZCO, in a span of 16 years has expanded its area and scope of activities promoting development to achieve good service and customer satisfaction.

Al Bilad Industries and Trading FZCO are a leading manufacturer of metal and wooden furniture, specifically for banqueting furniture.

We are supplying high quality products for hotels, restaurants, café, labor accommodations, schools and universities. Our production line is completely automated with modern machineries to maintain the quality and productivity.

Al Bilad Industries had been awarded ISO 9001:2000 certificate in the year of 2002 for Quality Management System Standard.

We assure that we shall support our clients by providing high quality products with competitive prices which meet international specifications and market requirements.

Moreover, our products offer convincing advantages of long service life and optimum efficiency with a wide margin of protection against over loading. Maximum safety is built-in by strict control and adherence to National and International safety regulations.

# INDEX

- Chairs
- Banquet
- Trolleys
- Conference
- Cocktail Tables
- Buffet Table
- Room Service Trolley
- Stage







c h a i r s

# bubba

The collection has stood the test of time, its classic styling comes with an ergonomically approved shape, the mentioned models and their designs are true timeless classic.

This framing is available in aluminum fluted, double groove or plain profile with comfort seat and back, models have the option of coming with normal seat and back.

All models are available with arms and can be stacked 10 high.

A wide variety of finishes and fabrics can be selected from BIT collection or specified by the customer.

Accessories such as linking system, writing tablets and chair trolleys are available.







CH.F 001A

92 56 60 48 10 6.2



CH.F 001

92 45 60 48 10 5.5







CH.F 002AB

92 45 60 48 10 6.0







CH.R 003

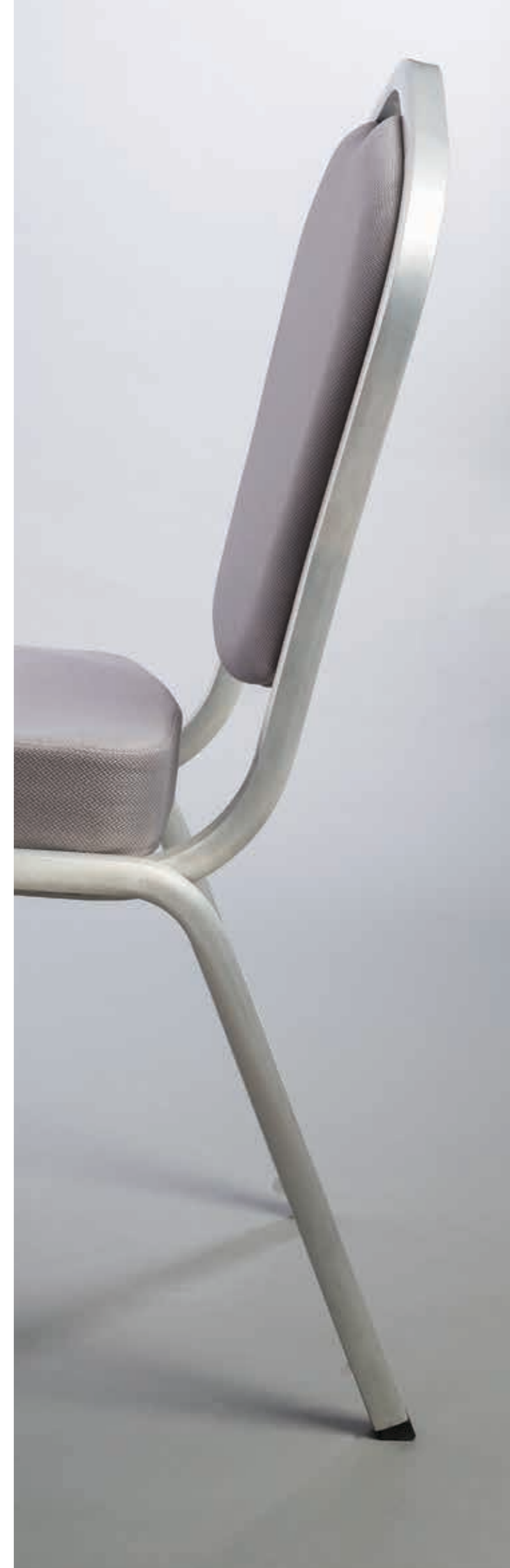



92 45 60 48 10 5.3

CH.F 004



CH.F 004A

92 56 60 48 10 6.2







CH.D 005

93 45 60 48 10 5.6 Kg







87 42 59 47 10 5.5

CH.P 006



CH.P 007

89 44 60 46 10 5.0



CH.P 008

90 45 60 48 10 5.4

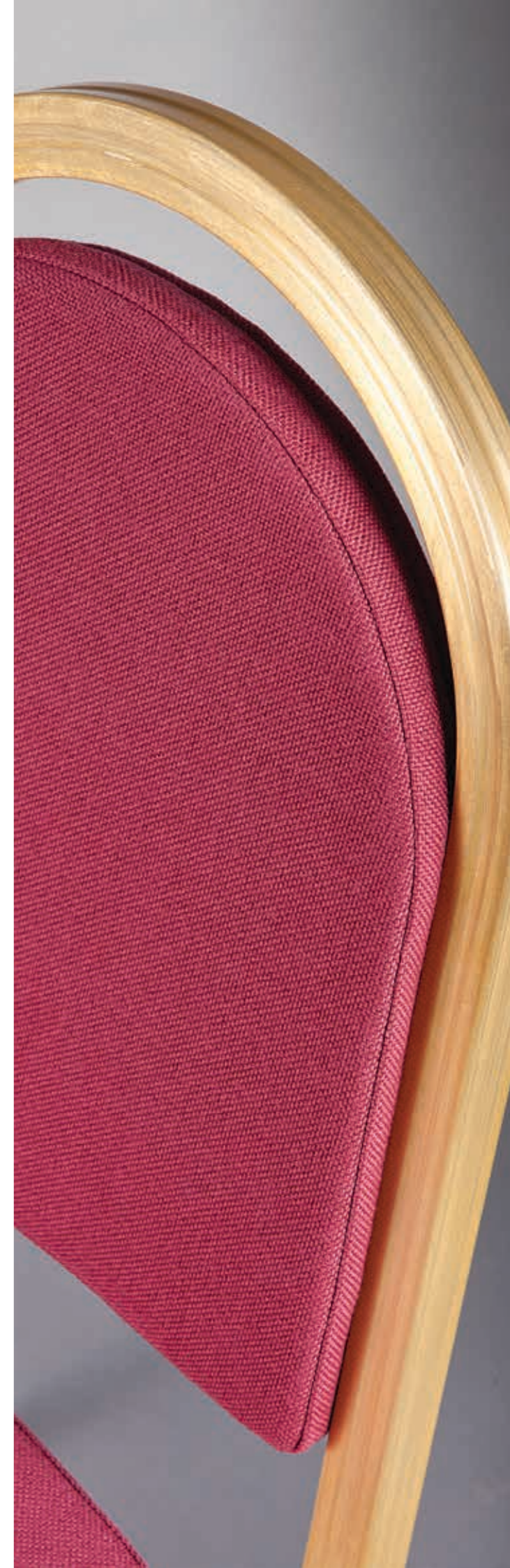





## Chair Linking



**CNT1**  
0.08 kg add to chair weight  
Standard linking in black

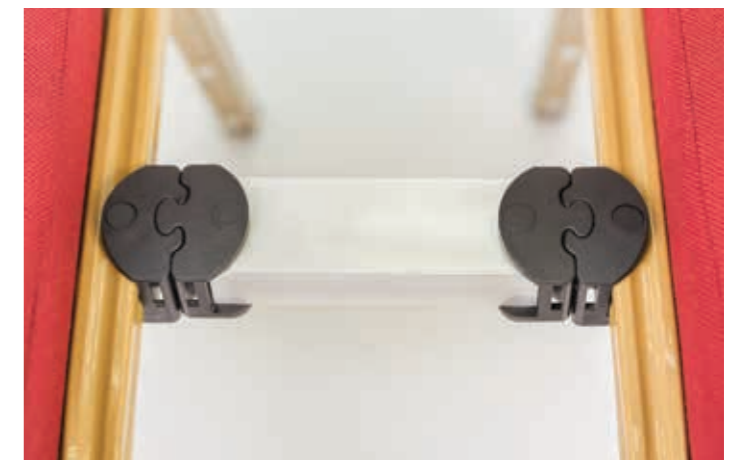

**CNT2**  
0.26 kg add to chair weight



**Linking Spacer:**  
Keep 20cm distance between chairs available on request.

# sonata

This collection has a modern look with a simple shape of curve and straight lines.

This framing is available in aluminum fluted, double groove or plain profile with comfort seat and back.

Models have the option of coming with normal seat and back.

All models are available with arms and can be stacked 10 high.

A wide variety of finishes and fabrics can be selected from BIT collection or specified by the customer.

Accessories such as linking system, writing tablets and chair trolleys are available.







CH.P009

91 45 60 48 10 5.7 Kg





91 45 60 48 10 5.4

CH.P010



CH.P011

93 45 60 48 10 5.5



CH.F011

93 45 60 48 10 5.5



CH.F012

93 45 60 48 10 5.5



CH.F013

93 45 60 48 10 5.5





Detachable Writing Tablet available for all models  
on request 2.8 kg add to weight



CH.P014



CH.P015





# arch

The collection has a unique, approved design, similar to architectural arch fragment.

This framing is available in aluminum fluted or plain profile with comfort seat and back.

Models have the option of coming with normal seat and back.

All models are available with arms and can be stacked 10 high.

A wide variety of finishes and fabrics can be selected from BIT collection or specified by the customer.

Accessories such as linking system, writing tablets and chair trolleys are available.







95 45 60 48 10 5.5 Kg

CH.F016



CH.P016  
95 45 60 48 10 5.5 Kg





94 45 60 48 10 5.5 Kg

CH.P018



Writing tablet available for all models on request 2.8 kg add to weight



CH.P017

94 45 60 48 10 5.5 Kg

# time

Elegant aluminum staking chair ergonomically designed comes with an approved shape, with extra features for comfort seat and back.

This framing is available in aluminum fluted, double groove or plain profile with comfort seat and back.

Models have the option of coming with normal seat and back.

All models are available with arms and can be stacked 10 high.

Accessories such as linking system, writing tablets and chair trolleys are available.

A wide variety of finishes and fabrics can be selected from BIT collection or specified by the customer.







CH.F019

95 45 62 48 10 5.5

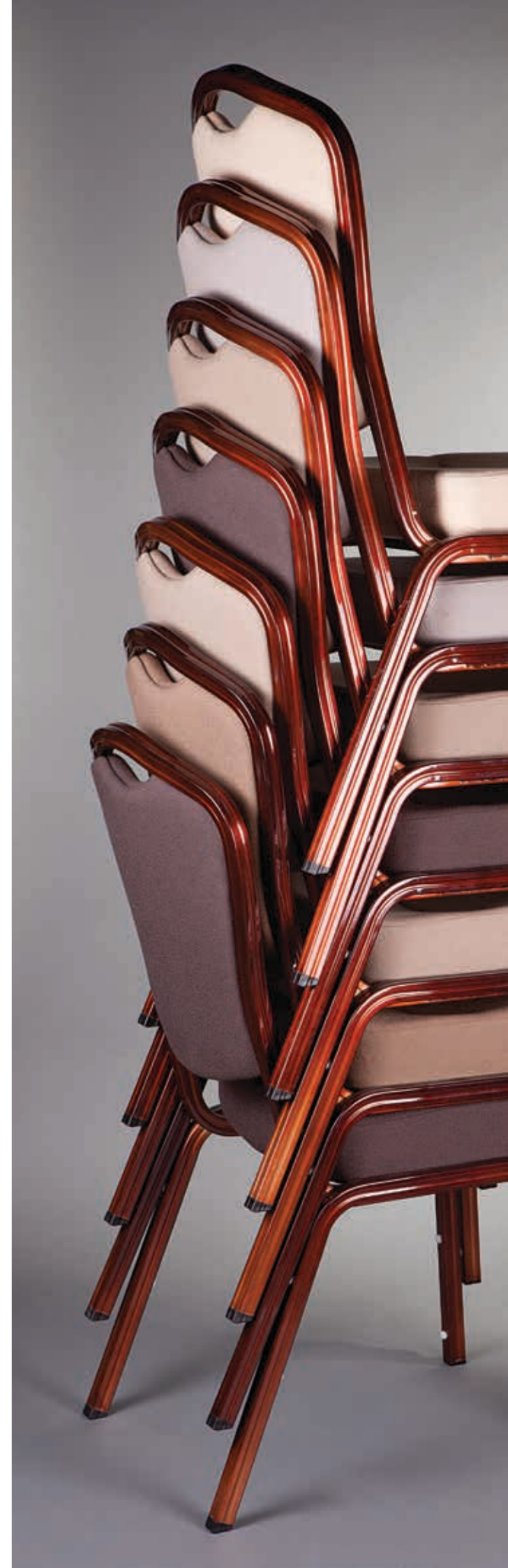





CH.F 020AB

93 45 60 48 10 5.8



CH.D 021

93 45 60 48 10 5.5





# luna

Elegant aluminum stacking chair ergonomically designed, with extra features for comfort seat and back.

Model has the option of a back plate design giving special look and meaning, can have variety of designs related to the customer request.

All models can be aluminum fluted, double groove and plain profile.

A wide variety of finishes and fabrics can be selected from BIT collection or specified by the customer.

All models are available with arms and can be stacked 10 high.

Accessories such as linking system, writing tablets and chair trolleys are available.

1. Standard plastic link available in black or gray on request.
2. Attachable writing tablet on request.
3. Classical arm available on all models add 12 cm to width.





93 45 60 48 10 5.3

CH.F.022



CH.F.023

93 45 60 48 10 5.3



CH.F.024

93 45 60 48 10 5.5







CH.F025

93 45 60 48 10 5.3 Kg

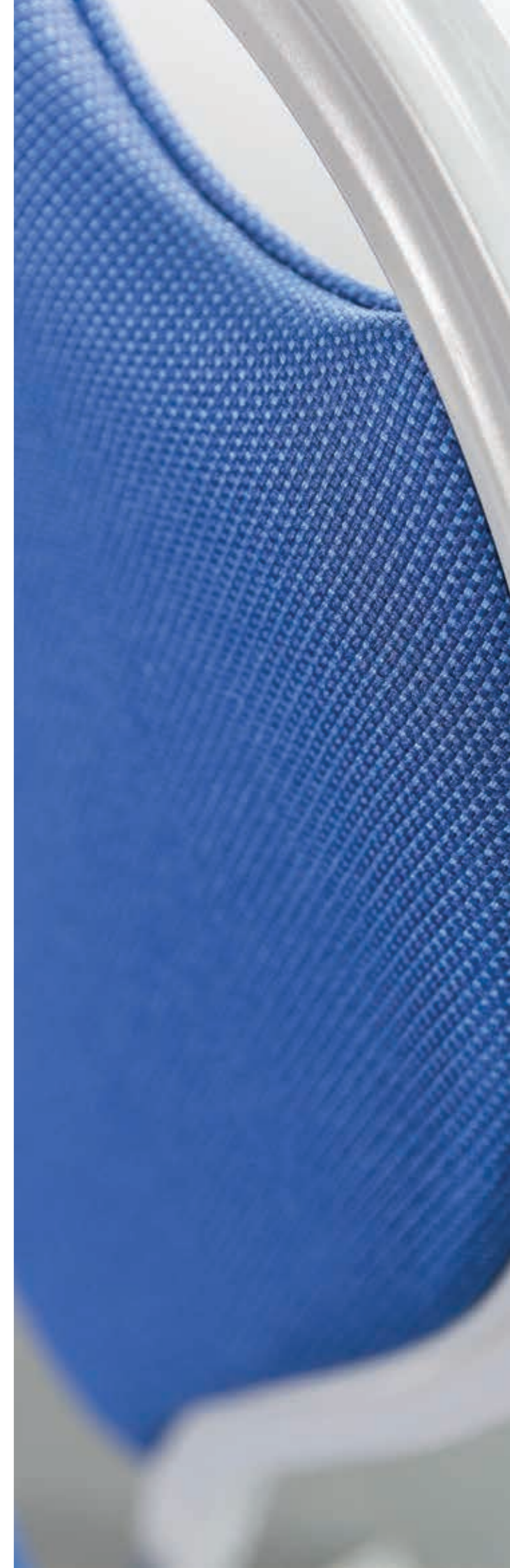





92 45 62 48 10 5.5

CH.D 026



CH.F 027

92 45 60 48 10 5.0



CH.F 028

92 45 60 48 10 5.2





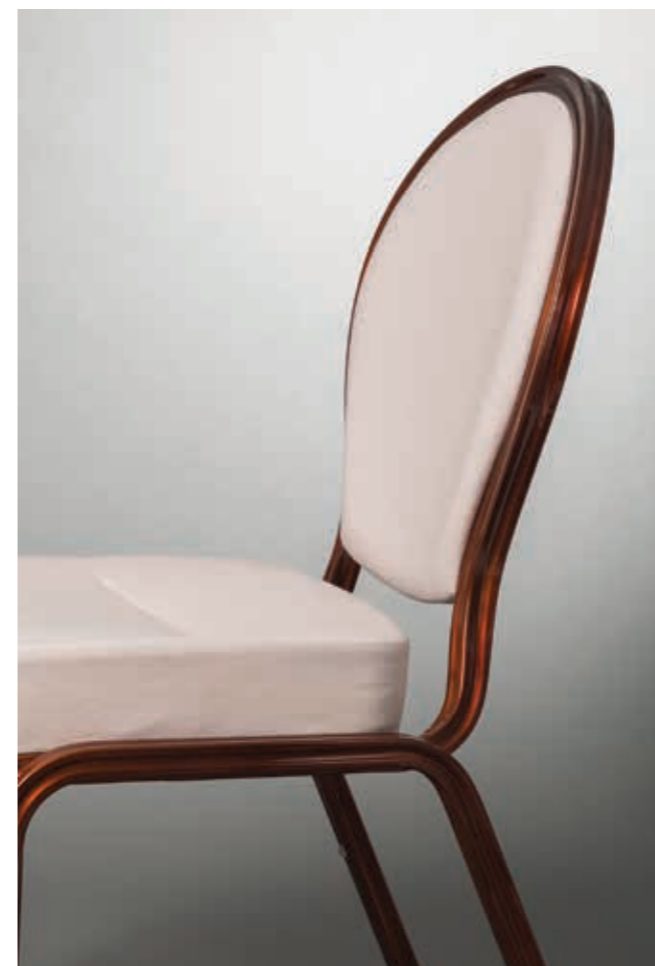

CH.F 029

92 45 62 48 10 6.3



# all season

The straight, strong lines and generous proportions together with superb comfort ensure the chair remains one of the most required banquet chairs in the market.

This model is available in aluminum fluted and plain profile.

A wide variety of finishes and fabrics can be selected from BIT collection or specified by the customer.

Chair can be stacked 5 high and is available with or without arm.







CH.P030



CH.P031







CH.F 032

96 45 60 48 4 6.4 Kg



CH.F 032A

96 56 60 48 4 7.3 Kg





# solo

Simple designed chair made of Steel plain profile. Seat & back are made of normal foam with comfort seat as an option as per client request.

A wide variety of finishes and fabrics can be selected from BIT collection or specified by the customer.

All models are available with arms and can be stacked 10 high.

Accessories such as chair trolleys are available.





92 44 60 47 10 6.8

CH.S 033



CH.S 034

92 44 60 46 10 6.3



CH.S 035

92 44 58 46 10 6.5



CH.S 036

92 44 60 47 10 6.3



CH.S 037

92 44 60 46 10 6.3





### **Foldable Banquet table**

Banquet tables feature a strengthened and easy to handle locking mechanism.

Legs and frame finish is special powder coat.

Our water resistant nylon flock coated table top reduces noise and cloth slipping.

There is one standard height is 76 cm

banquet tables



**Table Edges & Tops:**

Table edges are protected with special extruded aluminum rim and tops are made from 18mm chipboard either 18mm MDF, 18mm plywood as per client request depending on table size.

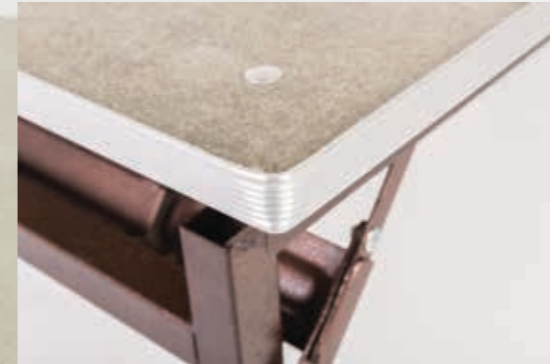

1. Rectangular nylon flock coated with aluminum edge.



2. Circular nylon flock coated rolled aluminum edge.

3. Melamine anti-scratch MDF top with matching PVC edge from supplier collection or with black rubber edging as per client request.



Plastic safety lock











Standard Foot

# Banquet Folding Table



# banquet tables



Shape	Model	Dimension	Folded Thickness
	BSF 1	L 122 x W 76 x H 76cm	7.5cm
	BSF 2	L 122 x W 45 x H 76cm	7.5cm
	BSF 3	L 152 x W 76 x H 76cm	7.5cm
	BSF 4	L 152 x W 45 x H 76cm	7.5cm
	BSF 5	L 183 x W 76 x H 76cm	7.5cm
	BSF 6	L 183 x W 45 x H 76cm	7.5cm
	BSF 7	L 210 x W 76 x H 76cm	7.5cm
	BSF 8	L 240 x W 76 x H 76cm	7.5cm
	BSF 9	L 76 x W 76 x H 7.5	
	BSF 10	91cm Dia. round H 76cm	7.5cm
	BSF 11	122cm Dia. round H 76cm	7.5cm
	BSF 12	152cm Dia. round H 76cm	7.5cm
	BSF 13	183cm Dia. round H 76cm	7.5cm
	BSF 14	152cm quarter Round H 76cm	7.5cm
	BSF 15	76cm quarter Round H 76cm	7.5cm
	BSF 16	183cm x 91cm x H 76cm	7.5cm
	BSF 18	101cm x 76cm x H 76cm	7.5cm
	BSF 19	183cm x 91cm x H 76cm	7.5cm
	BSF 20	152cm x 76cm x H 76cm	7.5cm
	BSF 21	274 OD cm x 122cm ID H 76cm	7.5cm
	BSF 22	183cm x 152cm x H 76cm	7.5cm
	BSF 23	122cm x 76cm x H 76cm	7.5cm



Each model has a specific designed table trolley for room to room transportation. Quantity and model of trolley as per client request.

**CAD Service**  
Our CAD department is available to assist clients with product selection and specification as per site plan and layout



t r o l l e y s





c h a i r t r o l l e y s

CHT 001



CHT 002



t a b l e t r o l l e y s



TTR 001



TTR 002





t a b l e t r o l l e y s







c o n f e r e n c e



# c o n f e r e n c e   c h a i r s



## Conference Chair

Chair is designed for meeting and conference facilities. Model is designed for comfort and style. The Chrome plated steel frame upholstered arm pads are finished to the highest standard, Dark gray or black color fabric are standard, other color fabrics can be selected from the supplier collections or as specified by the customer. Model can be stacked 4 chairs.





93 57 60 48 4 11 Kg

CCH 001



BITB









## Conference Tables

Foldable conference table has easy folding leg mechanism, legs are chrome plated.

Top, front and side modesty panels are anti-scratch quality melamine 18mm MDF with PVC matching edge from supplier catalog, high pressure laminate top is an optional.

Front and side modesty panels are an option as per client request.

For transportation from room to room table trolley as per client request.

	<b>Rectangular</b>	<b>Dimension</b>		<b>Quadrant</b>	CTQ-1	75cm
	CT-1	180 x 75 cm		CTQ-2	60cm	
	CT-2	150 x 75 cm		CTQ-3	45cm	
	CT-3	120 x 75 cm		<b>Triangular</b>	CTT-1	75cm
	CT-4	180 x 60 cm			CTT-2	60cm
	CT-5	150 x 60 cm			CTT-3	45cm
	CT-6	120 x 60 cm		<b>Modesty Panels</b>	MpF180	180x35cm
	CT-7	180 x 45 cm			MpF150	150x35cm
	CT-8	150 x 45 cm			MpF120	120x35cm
CT-9	120 x 45 cm	MpE75	75x35cm			
	<b>Half Round</b>		MpE60		60x35cm	
	CT-10	150 x 75 cm	MpE45		45x35cm	
	CT-11	120 x 60 cm				
	CT-12	90 x 45 cm				



## conference tables



Quadrant corner



### CAD Service

Our CAD department is available to assist clients with product selection and specification as per site plan and layout



Triangular corner





Two tables can be connected together suitable for meeting areas



Table connector



Tables with front modesty panel

The tables can be stacking and storing



Folding Mechanism



Adjustable foot





cocktail tables



# Glass Cocktail Tables

## Foldable Glass Cocktail table

FGCT-R, FGCT-S, FGCT-T

Glass cocktail table is easy and flexible folding table, Glass top with folding frame has a compact stacking facility in side of the trolley, easy for movement and storing.

Box trolley accommodates 10

tables.

10 mm Tempered Glass seating on steel chrome plated frame with special designed SS flange, frame has leveler bushes for leveling table after assembling.

Standard frame is Chrome plated powder coating is optional.

Top Standard glass shape is round or triangular

Square top is optional as per client request. Triangular model is designed as a single table and can be transformed into group of tables side to side forming multiple shapes on layout, option of glass bridge connecting the tables on a different heights allow to create an interesting buffet landscape, giving more functionality to organize banquet areas and rooms.



FGCT-T



Tables side to side

FGCT-R  
size: Glass Top 68 cm Dia.  
Frame Height 105 cm

FGCT-S  
Size: Glass Top 68 cm x 68 cm  
Frame Height 105 cm

FGCT-T  
Size: Glass Top 54 x 54 x 54 cm  
Frame Height 105 cm



## Glass top mounting

The Cocktail-Tables and most of the Buffet-Tables have a special featur to fix the glass-top to the base.

The screw is mounted undetachable on the base.

All the glass tops are produced as safety glass.

In case of damage, they will break into small pieces to avoid any injury.



FGCT-TBR

Glass bridge connecting two tables



GCT-T02

Special trolley



# c o c k t a i l   t a b l e s



**Foldable Cocktail Table**  
Folding legs for easy storage, top is nylon flock coated 18mm chipboard.  
Nylon flock coated 18mm MDF or plywood as per client request.

FCT-R



FGCT-R

Folding Cocktail Table  
With Glass Top



GCT-R

Cocktail Table With Glass Top



GCT-T01

Cocktail Glass  
Table Trolley





Stable, strong and elegant metallic finished frame, combined with clear glass top has become very popular in hotels as a buffet table set, tables with different frame heights allow to create an interesting buffet landscape, giving more functionality to organize banquet areas and rooms.

buffet table



# b u f f e t t a b l e s



BGT 001

For easy arrangements and transportation, tables set have the option of wheels (front two with brake) or leveler bushes as per client request.

10mm clear tempered glass seating in side of table's frame. Set designed to be stackable, easy for storing.

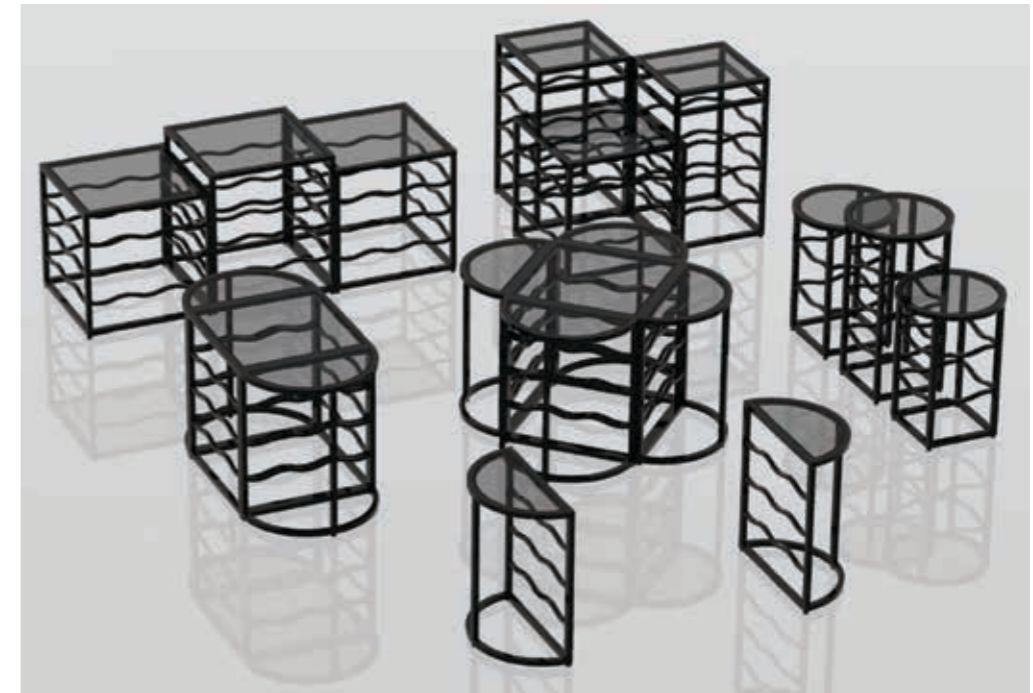

BGT 002

All the glass tops are produced as safety glass. In case of damage, they will break into small pieces to avoid any injury.

## Stacking Buffet set has four tables one set consist of sizes

- L 168 x D 85 x H 90cm
- L 156 x D 80 x H 85cm
- L 144 x D 75 x H 80cm
- L 132 x D 70 x H 75cm

## Buffet tables set



BGT 003

### Half Round

- 60 Dia. x W 30.0 x H 100cm
- 75 Dia. x W 37.5 x H 75cm
- 75 Dia. x W 37.5 x H 85cm
- 75 Dia. x W 37.5 x H 95cm



BGT 004

### Round

- 60 Dia. x H 75cm
- 60 Dia. x H 85cm
- 60 Dia. x H 95cm
- 60 Dia. x H 100cm



BGT 005

### Square

- L 60 x D 60 x H 100cm
- L 75 x D 75 x H 75cm
- L 75 x D 75 x H 85cm
- L 75 x D 75 x H 95cm



# b u f f e t t a b l e s



BGT 006

## Rectangular Glass Buffet Table

Tables are designed to be stackable easy for storing. One set has four tables

Tables set has wheels (front two with brake) for transportability and easy arrangements, different frame heights allow to create an interesting buffet landscape giving more facility to organize banquet areas and rooms.



SS Frame Brush Finesh



MS Frame Powder Coated



Weel with lock



SS Flange

ALUM Frame Powder Coated

**One set consist of sizes:**

Large: L 196 x D 80 x H 90cm

Med.: L 180 x D 80 x H 81cm

Small:L 80 x D 80 x H 72cm

Top 10mm Clear Tempered Glass having special designed SS flange for seating on frame.

Standard set frame is aluminum 50x 50x4mm profile powder coated elegant metallic colors from suppliers collection.

SS brushed finish and steel powder coated frame option is available as per client request.



# b u f f e t t a b l e s

## Half Round Glass Buffet Table

Tables are designed to be stackable easy for storing. One set has 3 tables  
Big table Frame is steel tube powder coated  
Top 10 mm Clear Tempered Glass,  
Glass top seat on the frame with special designed SS flange



**One set consist of sizes:**  
L 150 x D 75 x H 85cm  
L 100 x D 50 x H 25cm  
L 60 x D 30 x H 20cm

Medium and Small Tables Top 8 mm Clear Tempered Glass with Special Designed SS flange.  
Legs of Tables Removable Chrome Plated Round Pipe with Plastic end bush

## Mobile Buffet Unit

Buffet table like the folding table comes with a standard folding mechanism. The buffet table comes with fixed wheels with fold neatly under table. Two wheels with lock.  
Mobile buffet table comes with two option of nylon flock coated 18 mm chipboard or 18 mm MDF. Options are included for the mini clamp on top table  
Melamine anti-scratch top with matching PVC edge or rubber black edge is optional as per client request.



MBTF 01

## Table Edge:

Table edges are protected with special extruded aluminum rim.



Mini clamp



wheel with brack



Folded legs

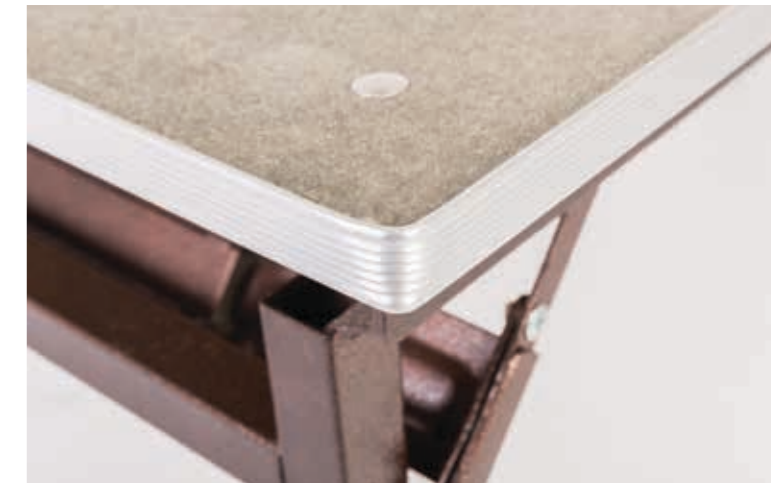

Rectangular nylon flock coated with aluminum edge.



room service trolley



# room service trolley



## ROOM Service Trolley RST.001

BIT Room Service Trolleys has a standard height of 76cm, top W 107cm X L 94 cm open position, flaps folded down top: W 67cm X L 94 cm, standard top finishes are quality melamine anti-scratch MDF with black PVC edges, high pressure laminate top is an optional.

Room Service Trolley has a feature tri-fold flaps and tilting top. Flaps fold down for maneuverability in lifts, passing doors and corridors.

Trolley has grills fitted as standard to carry two food Warmer Boxes.



Table top folds to vertical



Trolleys can be stored in echelon to minimize storage



Pull up the grill to release the lock



Lower the grill



Resting the grill



Trolley has grills fitted as standard to carry two food Warmer Boxes.



# room service trolley



Flap down



Fold up flap



Extend flap stay to secure for use



Retract flap stay



Extend Flap



Raise flap



Flap to secure in vertical position



Unlock to tilt the top for storage



Trolley with tri-fold flaps up to assist when cleaning away





The Folding screen is designed for dividing areas and rooms. Folded screen has an option of 3 and 2 panels. Screen folding makes it easy for traveling and storing.

Screen can be manufactured to complement your color scheme from our fabric collection or suitable fabric can be specified, melamine MDF from supplier collection matching client request as an option.

Special locking system is available for locking separate units to each other.

folded screen

# f o l d e d   s c r e e n



## Dimension

Overall Height: 180cm

Overall width 45cm

Length when full extended 241cm

One panel size: L 80 cm

Folding Position



## Folded Screen and single partition

Frame is 30x30 steel sq. tube powder coated finish in black, other option can be specified from available color chart as per client request.



Single panel partition is available  
size: L 80 cm X 180 cm H, Width 45 cm



Special feature to connect two partitions



## Podium

The Podium is manufactured from melamine MDF; color can be specified from available supplier collections as per client request.



p o d i u m

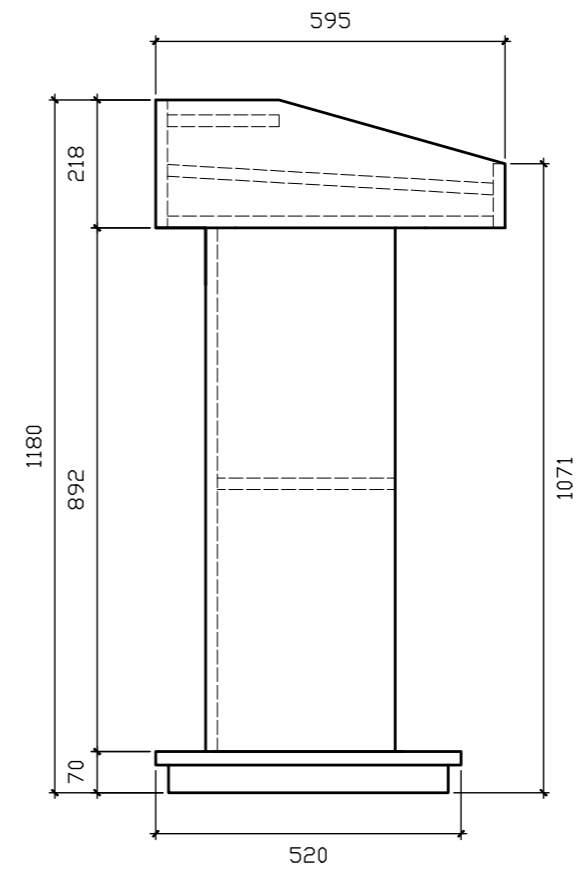

Side

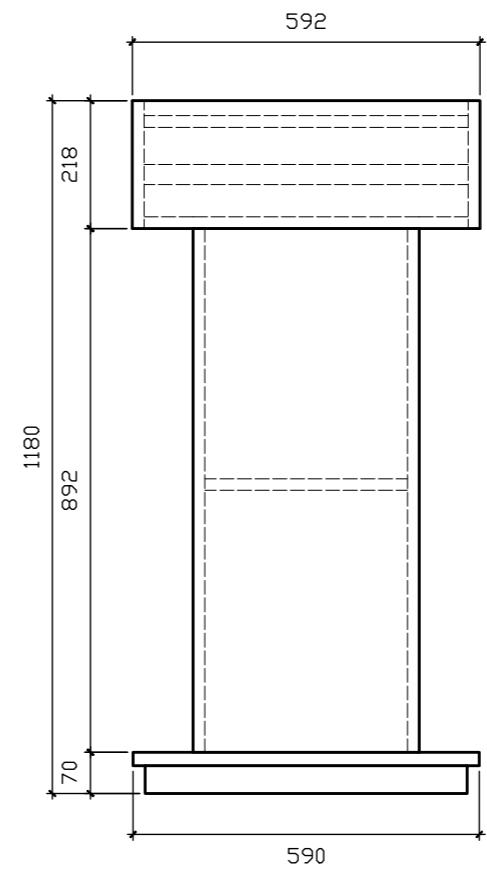

Front

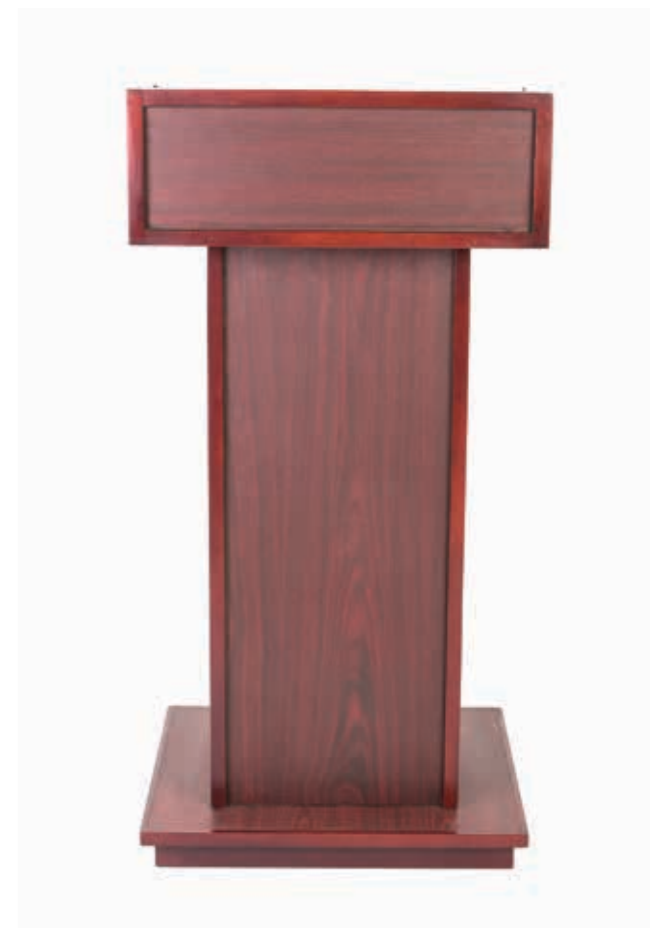





## Centerfold Stage

The portable staging system includes many features for easy operation. The stage has a lightweight strong steel tubular frame and extruded aluminum rim assembly ensuring stability.

The folding mechanism has a positive -lock which ensures the halves of the platform lock securely in their upright position.

The Aluminum rim provides integral mounting for a range of accessories including linking, skirting, fascia panels and guardrails.

centerfold stage



# centerfold stage



Roll Platform Into Position

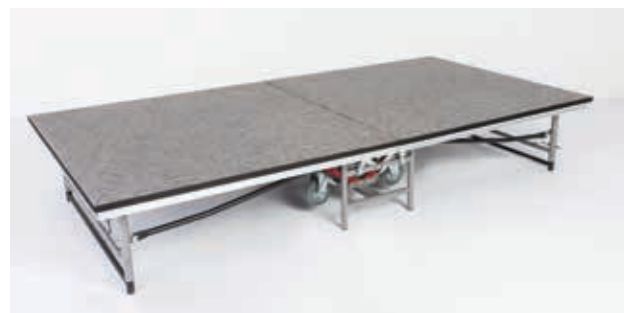

Single height:



Dual height:

## The Centerfold stage

is available in the following sizes and can be nested when folded for compact storage

**CFS 122** L: 244cm W: 122cm  
 Folded L: 122cm D: 50cm

Dual height: 40-60cm Weight: 120 Kg  
 Single height: 40cm Weight: 110 Kg  
 Dual height: 60-80cm  
 (H90cm is optional) Weight: 125 Kg  
 Single height: 60cm Weight: 115 Kg

**CFS 183** L: 244cm W: 183cm  
 Folded L: 183cm D: 50cm

Dual height: 40-60cm Weight: 149 Kg  
 Single height: 40cm Weight: 135 Kg  
 Dual height: 60-80cm  
 (H90cm is optional) Weight: 159 Kg  
 Single height: 60cm Weight: 140 Kg

## Steps

CFS-S40 H: 40cm W: 91cm  
 CFS-S60/CFS-S90 H: 60cm W: 91cm

## Linking

CFS-LINK  
 Handrails, skirting and Rump are available on request.  
 Platform covered of gray carpet Variation of carpet color as per client request.



Linking

# centerfold stage



Skirting

## Steps





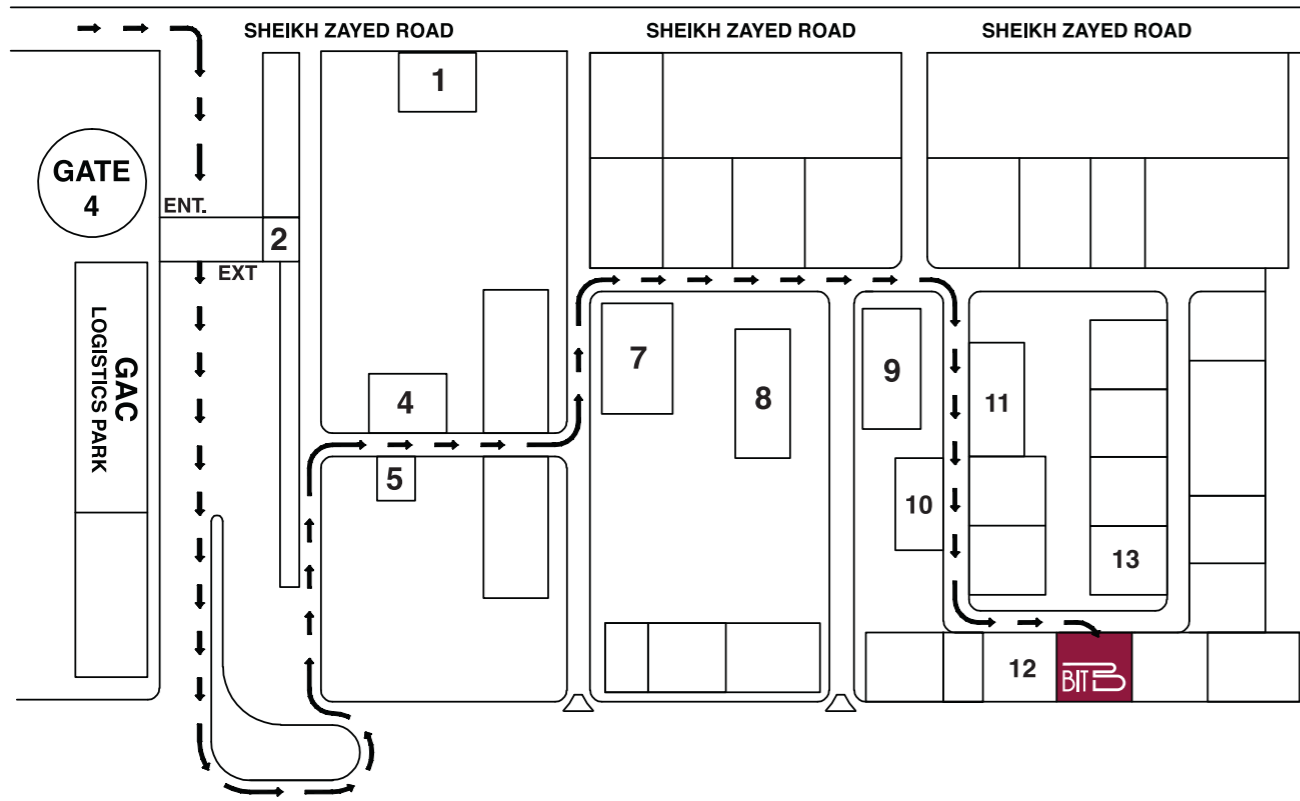

**NOTE: ENTER IN JAFZA GATE NO 4**

- |                                    |                                |
|------------------------------------|--------------------------------|
| 1. Jafza 14                        | 8. Maneesh                     |
| 2. Security Pass Office            | 9. Allied                      |
| 3. Guard                           | 10. Silk Route Beauty Products |
| 4. Jafza Foodcourt                 | 11. Maneesh                    |
| 5. Mosque                          | 12. Barloworld                 |
| 6. Swarovski                       | 13. Rolman World               |
| 7. Consolidated Shipping Logistics |                                |

BITB

